



TRIUMF

CANADA'S NATIONAL LABORATORY FOR PARTICLE AND NUCLEAR PHYSICS

*Owned and operated as a joint venture by a consortium of Canadian universities
via a contribution through the National Research Council Canada*

A liquid Xenon detector for micro- PET

P-A. Amaudruz¹, D. Bryman², L. Kurchaninov¹, P. Lu²,
C. Marshall¹, J. P. Martin³, A. Muennich¹, F. Retiere¹, A. Sher¹,
and V. Sossi²

1 TRIUMF, Vancouver, Canada

2 The University of British Columbia, Vancouver, Canada

3 The University of Montreal, Montreal, Canada

LABORATOIRE NATIONAL CANADIEN POUR LA RECHERCHE EN PHYSIQUE NUCLÉAIRE ET EN PHYSIQUE DES PARTICULES

*Propriété d'un consortium d'universités canadiennes, géré en co-entreprise à partir d'une contribution
administrée par le Conseil national de recherches Canada*

Micro Positron Emission Tomography



- Typical performances (LSO crystals)
 - Efficiency: 85%
 - 3D position resolution ~ 6 mm
 - Depth of interaction issue: crystal length ~ 30 mm
 - Resolution at center of field of view < 1.3 mm
 - Timing resolution: 3 ns (FWHM)
 - Energy resolution: $< 18\%$ @ 511 keV
 - Critical to reject scattered photons

Why liquid Xenon for PET?

A good scintillator

Parameter	BGO	LSO	LXe	Comment
Attenuation length at 511 keV	11 mm	12 mm	36 mm	Required depth ≥ 10 cm
Photo-electric fraction	42%	33%	22%	Require handling Compton interactions
# Photons at 511 keV	3,300	16,400	12,000 (2kV/cm)	
Decay time	300 ns	40 ns	2 ns (97%) 27 ns (2%)	< 1ns timing resolution possible in principle
Peak wavelength	480 nm	420 nm	178 nm	Require special photo-sensors

Why liquid Xenon for PET?

Adding charge measurement

- # electrons $\sim 20,000$ @ 511 keV (2kV/cm)
 - To be compared with typical electronics noise $\sim 1,000$ e- (equivalent noise charge)
- Charge collection can be 100% efficient
 - With proper care. 100 μ s e- lifetime require part per billion H₂O and O₂ level
- Position resolution defined by electrode granularity
 - Diffusion is very small 50 μ m for 10 cm drift length
 - True 3D position. No depth of interaction issues
- Ability to identify individual interactions
 - Compton and photo-electric

Why Liquid Xenon for PET?

- Superior energy resolution by combining light and charge
- Superior position resolution from charge
 - No depth of interaction issue
- Superior two-hit separations
 - Ability to measure individual interactions
- Continuous detection medium
 - Improved efficiency
- Superior timing resolution from light
- Lets see how we can make this work

Concept

A liquid Xenon TPC for PET

- Time Projection Chamber
 - Electron drift to anode pads or strips
 - Reconstruct position along drift length as time between light flash and e- arrival time on anode
- Segmentation of light sensors
 - Provide some position information
 - Necessary for light-charge matching at high rate
 - Electron drift time $0.2 \text{ cm}/\mu\text{s}$

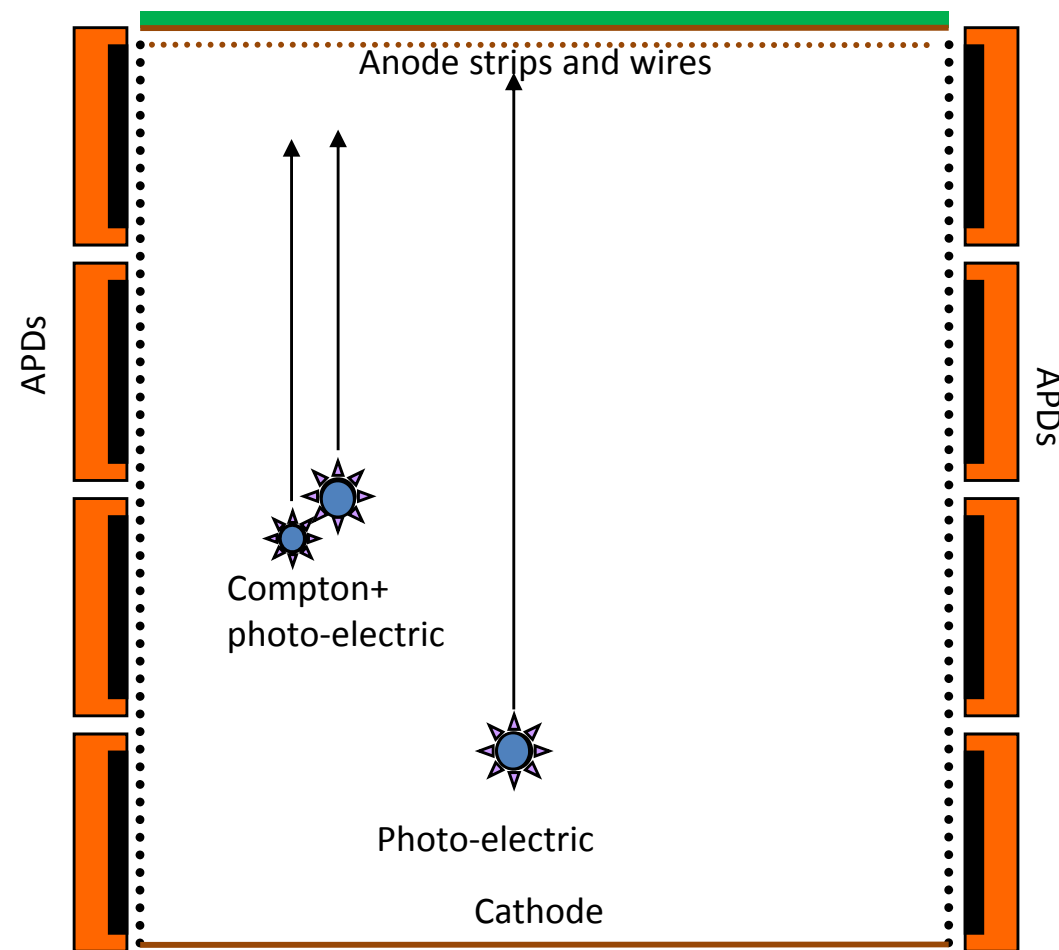

Micro-PET concept

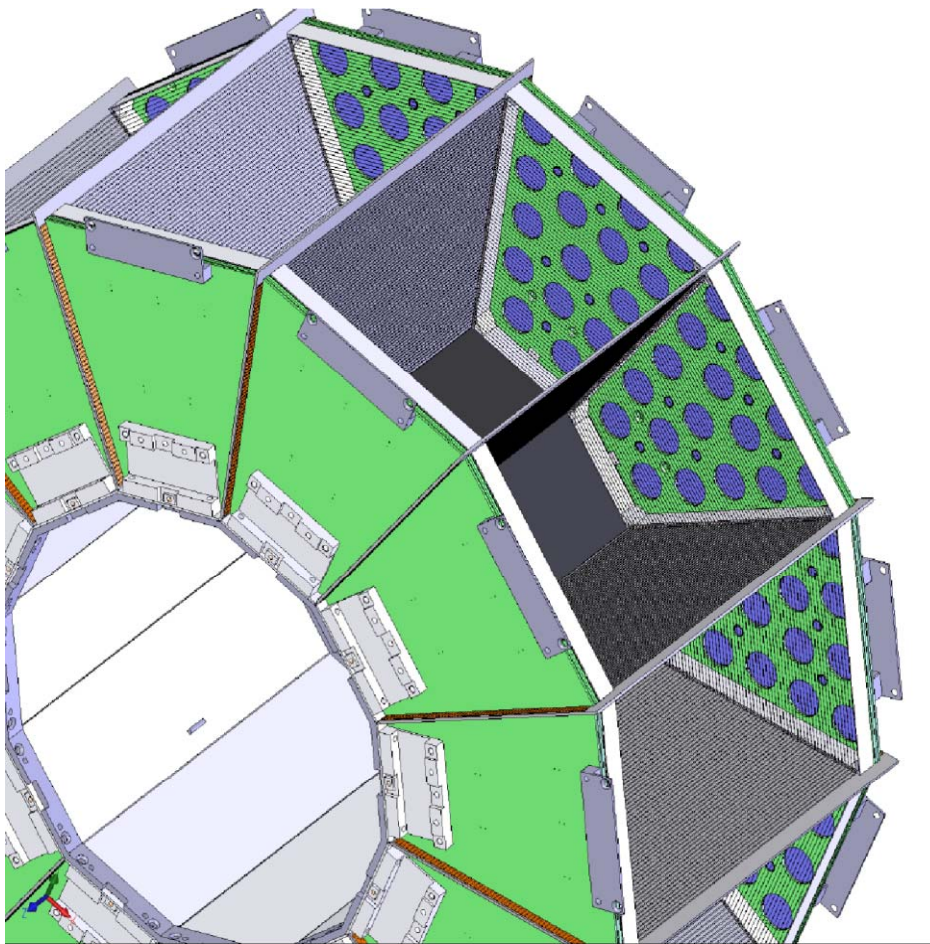

- 12 trapezoidal sectors
 - Axial length = 8cm
- Electron drift from inner to outer radius
 - Maximum drift length 12 cm
 - Readout on sets of strips and wires
- APDs on both side of the trapeze

Micro-PET concept

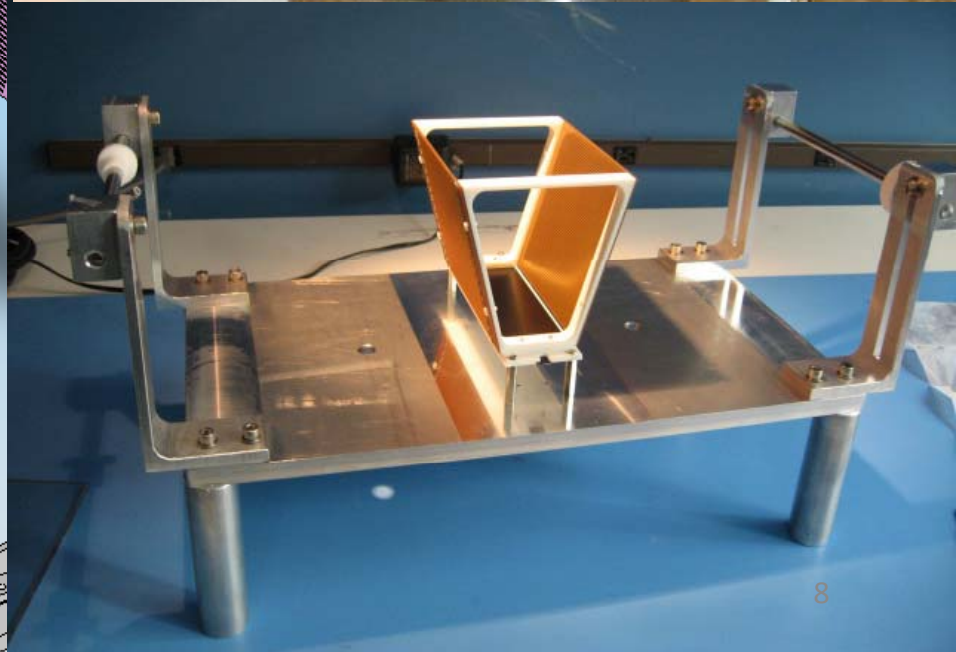
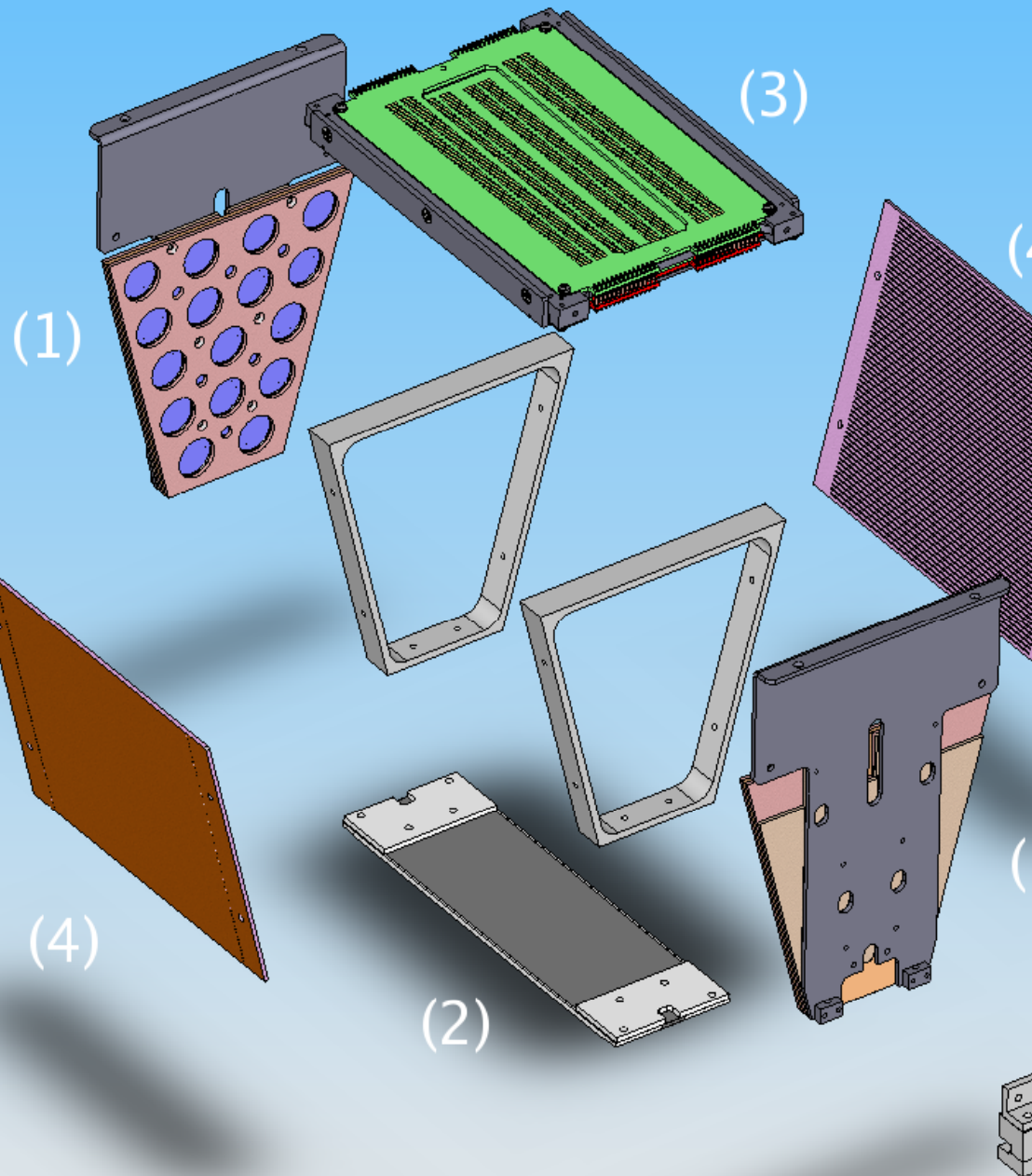

Current work

- Building and operating a sector prototype
- Addressing some liquid Xenon issues
 - How to optimize energy resolution?
 - Combining light and charge is required
 - What is driving the energy resolution
 - How to handle Compton interactions?

Energy loss in Liquid Xenon

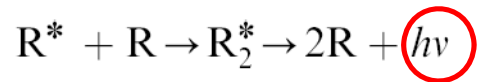

or

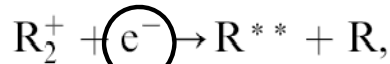
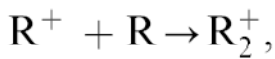

Deep UV light

Ionization

Heat (IR, phonon)

- Different type of quanta a produced
 - Scintillation
 - Enhanced by recombination
 - Ionization
 - Reduced by recombination
 - Heat/phonon
- Simple model:

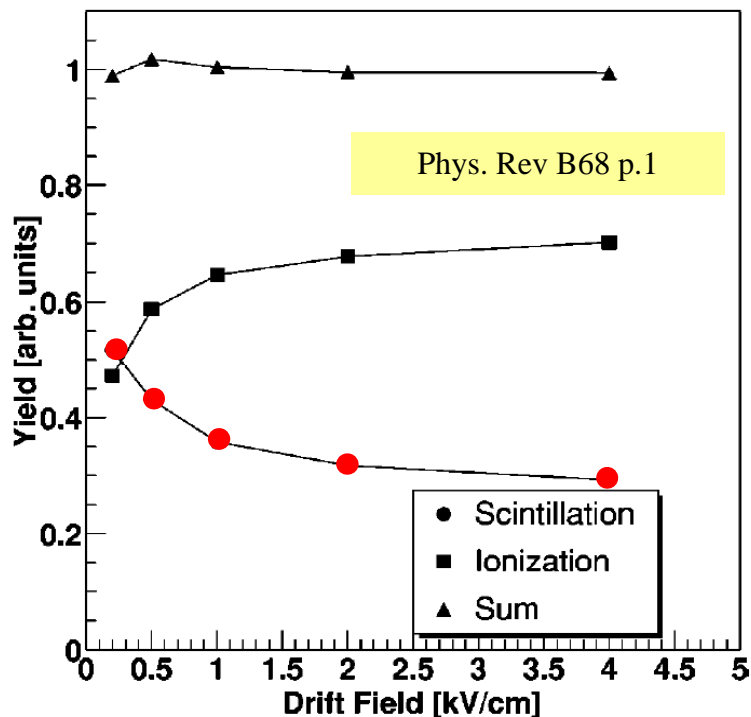

$$Q = Q_0(1 - Fr) \text{ and } S = S_0 + Q_0 Fr P_{q \rightarrow \gamma}$$

Q_0 Number of e^- -ion initially produced = $511\text{keV}/15.6\text{eV}$

S_0 Number of UV photons initially produced $\sim 0.2 Q_0$

Fr Fraction of e^- -ion recombining

$P_{q \rightarrow \gamma}$ Probability that a recombination produce a photon

Has been measured to be 1 (Aprile et al.)

Event by event fluctuations worsen the energy resolution

- Energy resolution from ionization much worse than Fano limit
 - Density fluctuations?
 - Variation of recombination
 - Correlation with scintillation improves resolution

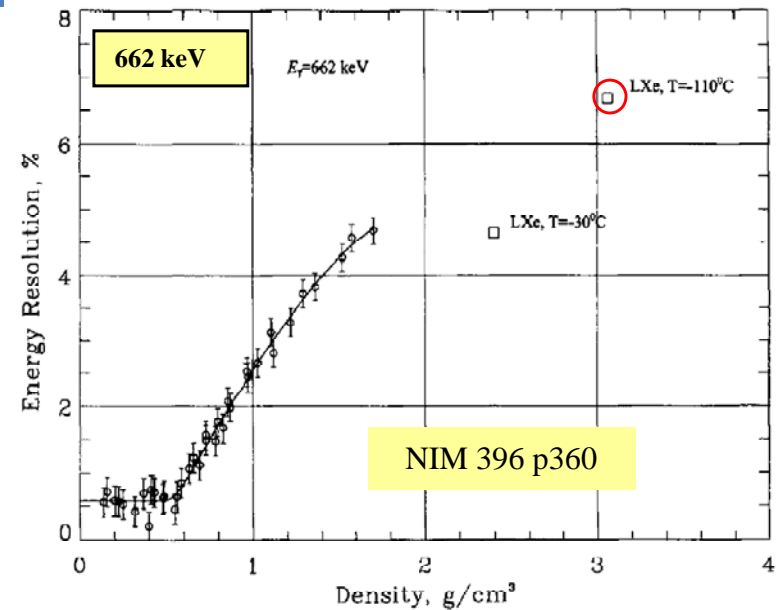

Phys. Rev. B68 p.054201

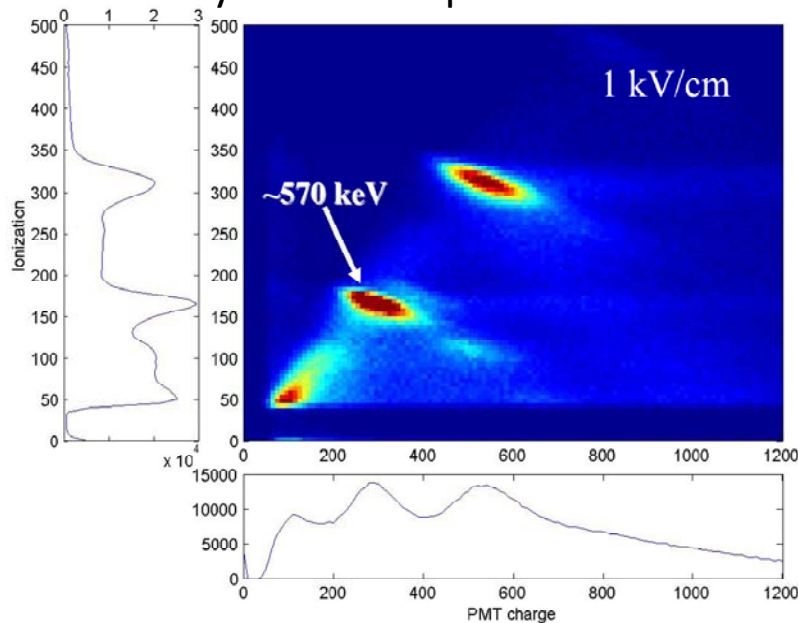

$$\frac{\Delta Q}{Q} = \frac{\Delta Fr}{(1 - Fr)} \quad \text{and} \quad \frac{\Delta S}{S} = \frac{\Delta Fr}{0.2 + Fr}$$

Introduce ΔFr the fluctuation of the number of recombining e^- -ion

Solution: combining light and charge

- 4% (sigma) has been measured
- Build a test chamber to investigate energy resolution
 - Use APD
 - Use Time Projection Chamber configuration

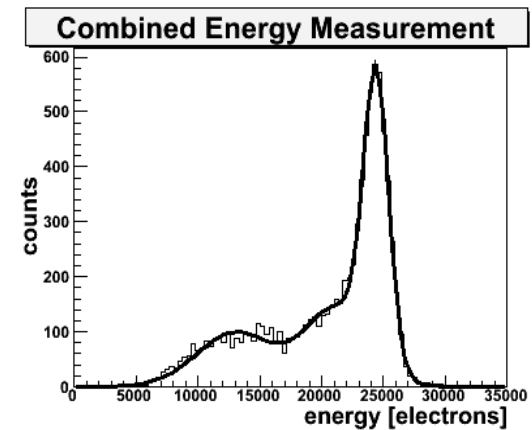
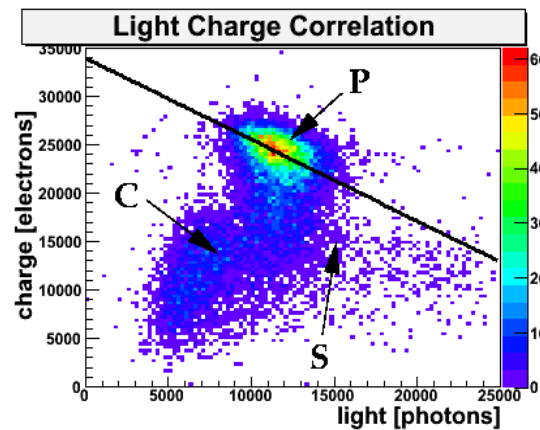
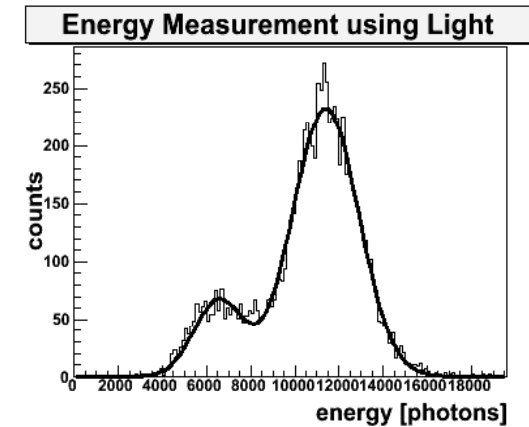
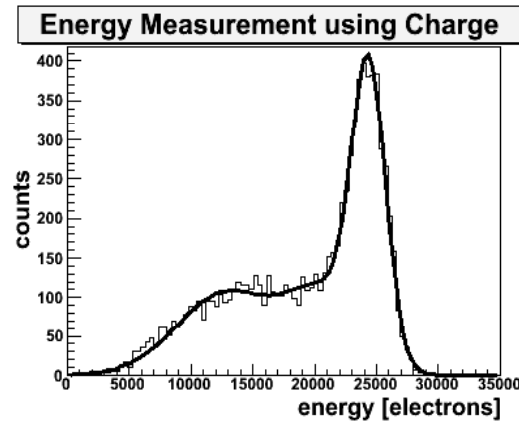
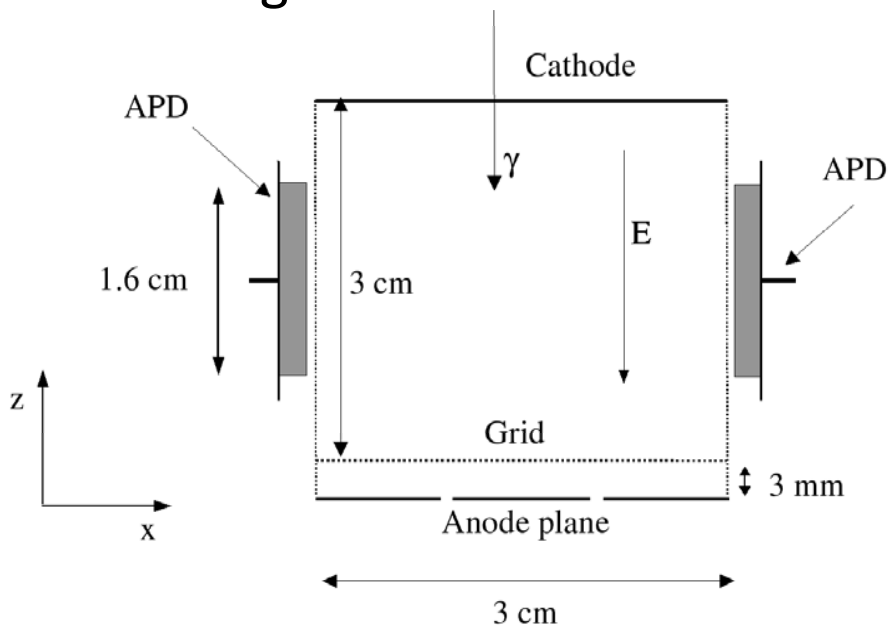

Energy resolution

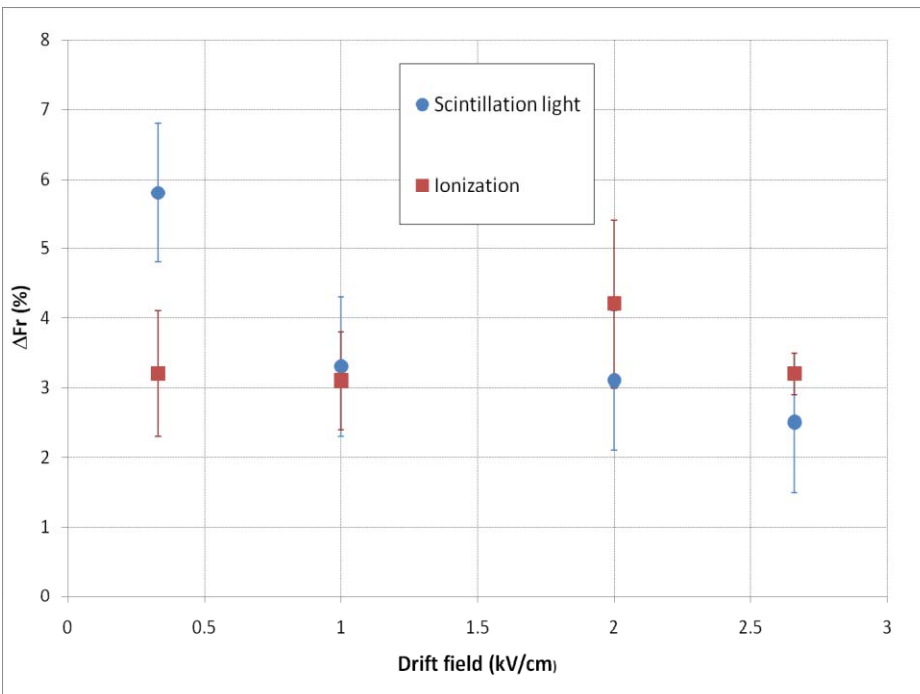
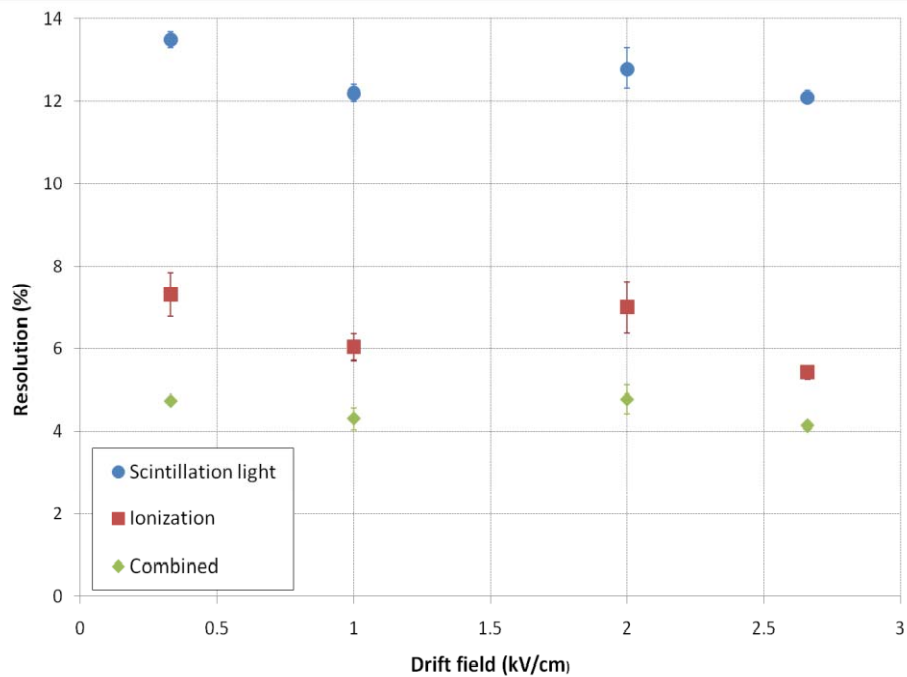

- Before combining resolution dominated by recombination fluctuations
- After combination main source of fluctuations:
 - Electronic noise on electrode (ionization)
 - 2.7%
 - APD gain fluctuation
 - 2.7%
- ΔFr parameterization is self-consistent

Dealing with Compton interactions

- The 1st interaction in Xenon is a Compton 78% of the time
 - Distance between the 1st and 2nd interactions exceed position resolution
- Finding the first interaction point is critical to achieve pointing resolution
- In addition Compton reconstruction may be used to reject background

A large number of configurations

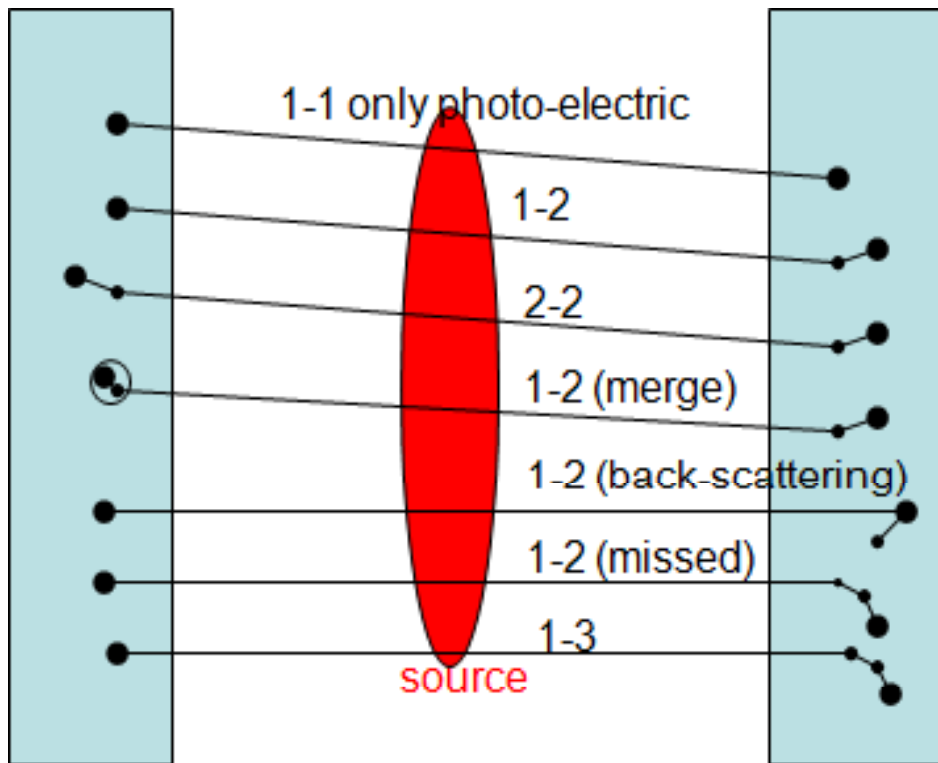

Topology	Intrinsic	2 hit distance > 1 mm	Hit E > 50 keV	both
1-1	7.6%	9.7%	9.7%	12.3%
1-2	20.8%	24.4%	28.0%	31.6%
1-3	12.6%	13.1%	12.5%	12.0%
1-4	4.9%	4.4%	2.2%	1.8%
2-2	14.1%	15.0%	20.2%	20.3%
2-3	17.3%	16.3%	18.1%	15.5%
2-4	6.7%	5.5%	3.2%	2.3%
3-3	5.3%	4.4%	4.0%	2.9%
3-4	4.0%	2.9%	1.4%	0.9%
4-4	0.8%	0.5%	0.1%	0.1%

No need to investigate higher order topological configurations

Compton reconstruction algorithm

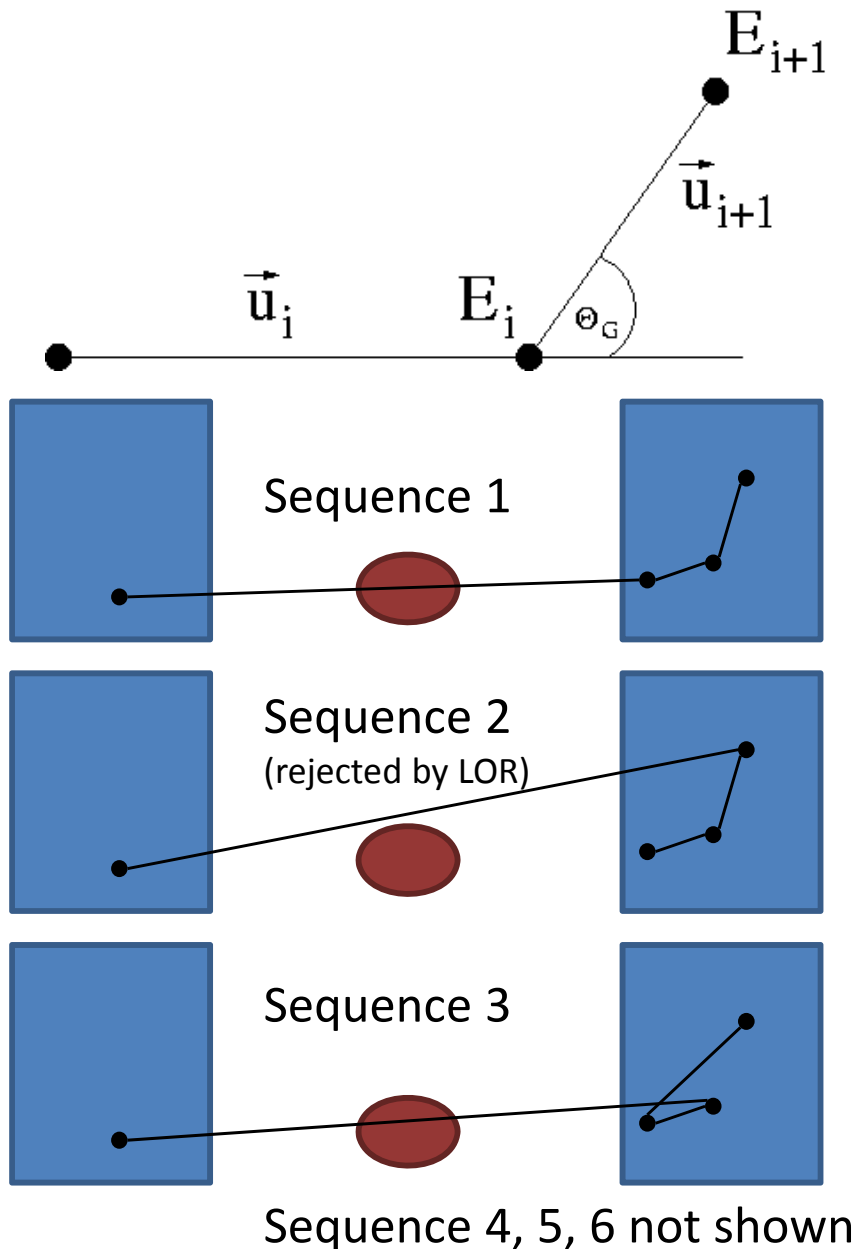

- Build every possible interaction sequence using the information on both detector sides
 - Reject the sequence that lead to Line of Response outside the sample volume
- For each sequence
 - Calculate two angles at every possible scattering point
 - From energy deposited
 - From geometry
 - Assess the errors of both methods (energy always dominate errors)
 - Calculate a chi2 quantity comparing the energy and geometrical angle
 - Select the sequence with lowest chi2

Algorithm evaluation by simulations

- Simulate using GEANT
- Use NEMA phantom scaled for micro-PET

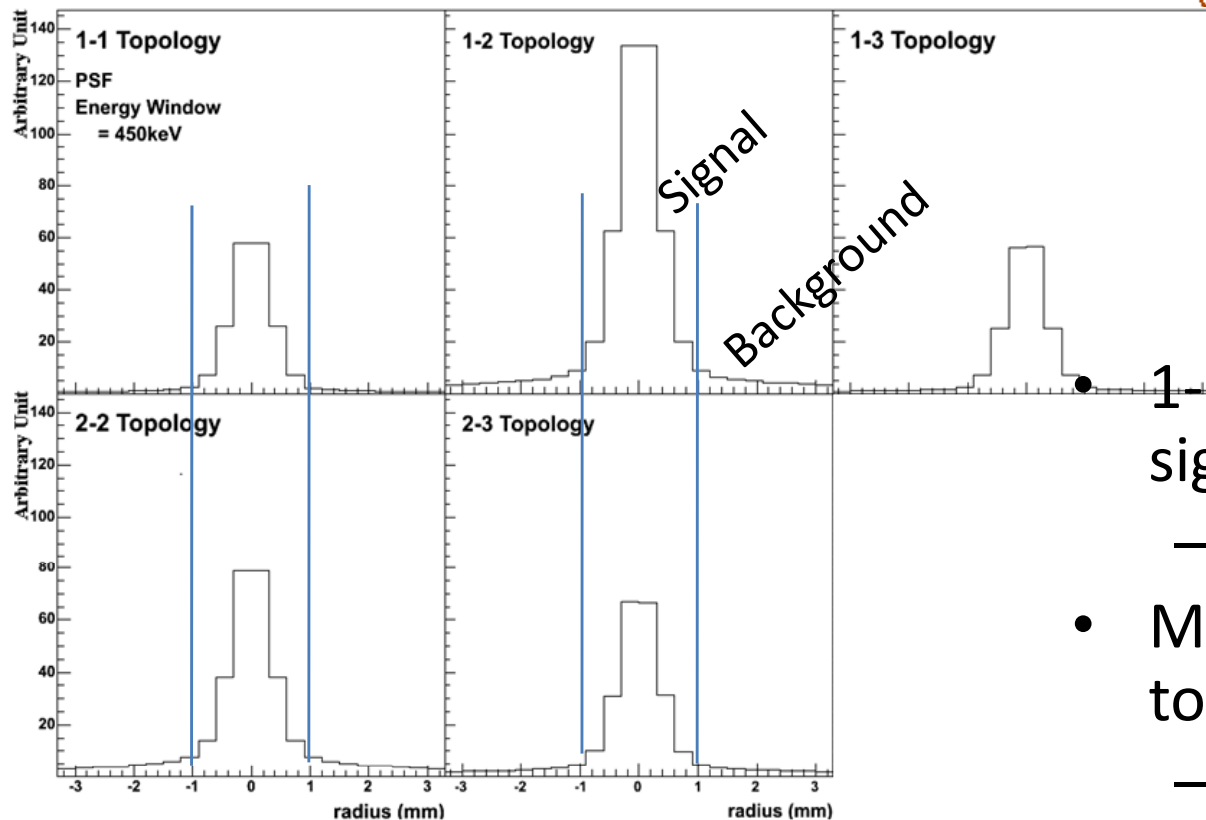
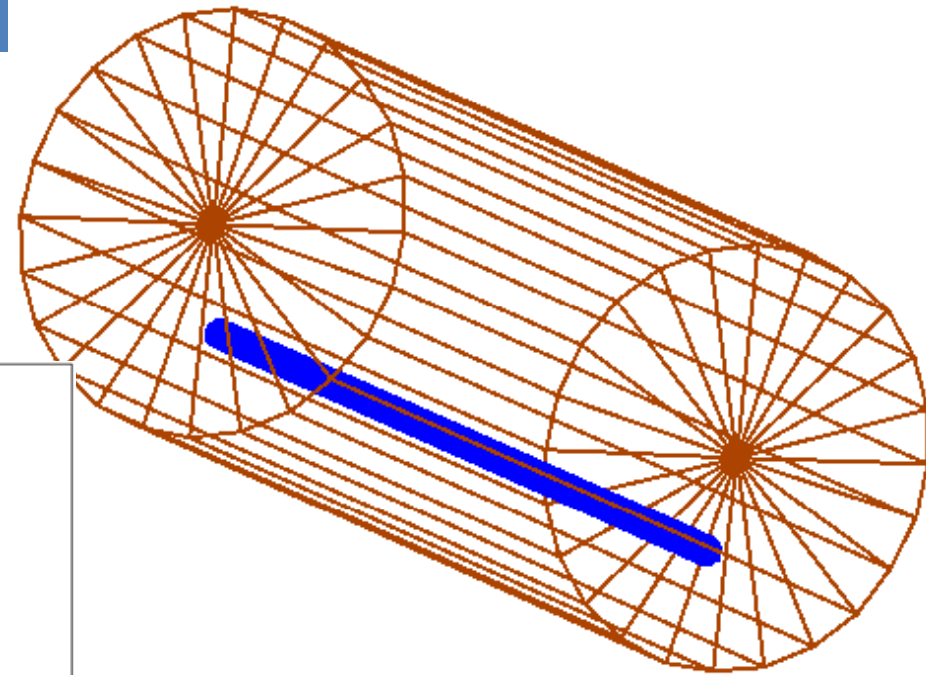

• 1-2 and 2-2 have the worst signal to background

– Some irresolvable ambiguities

• Most of the background is due to selecting wrong first point

– Random and scatter very much suppressed due to very good energy and time resolution

Some sequences are almost un-resolvable

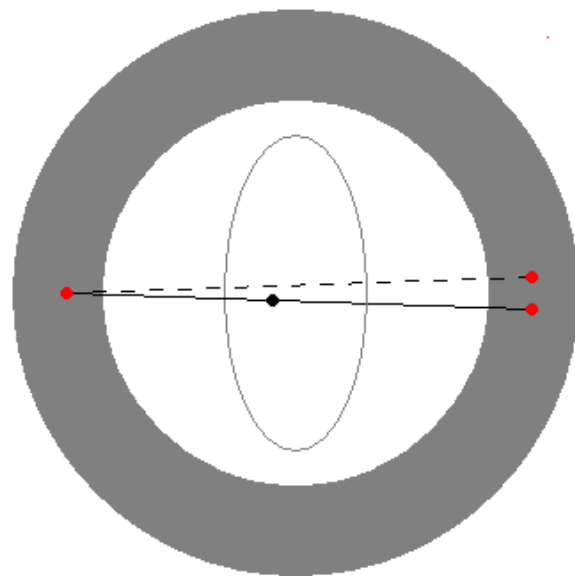

- Annihilation Point
 - Interaction Point
 - Possible LOR 1
 - - - Possible LOR 2
- $\theta_1 \sim \theta_2$
 $dE_1 \sim dE_2$

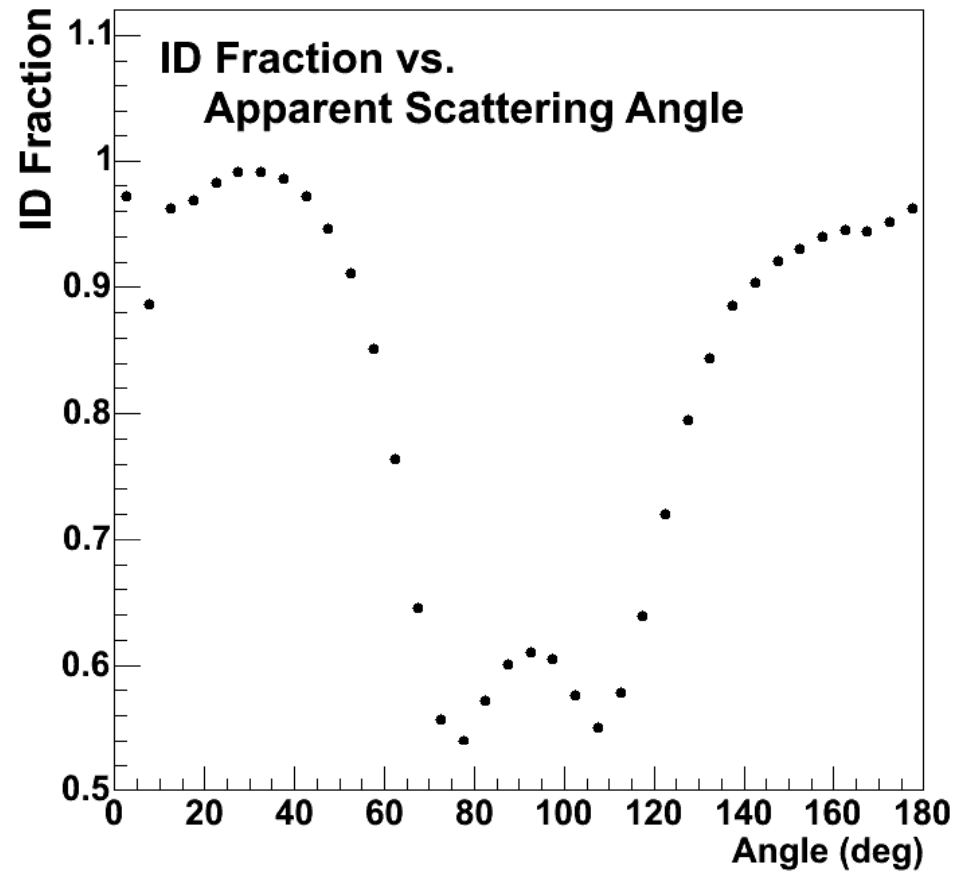

Using chi2 to reduce background

- Events with high chi2 could be removed
 - Price : loss of statistics
- Can remove scatter and randoms
 - However, 450keV energy window gets rid of most scatters

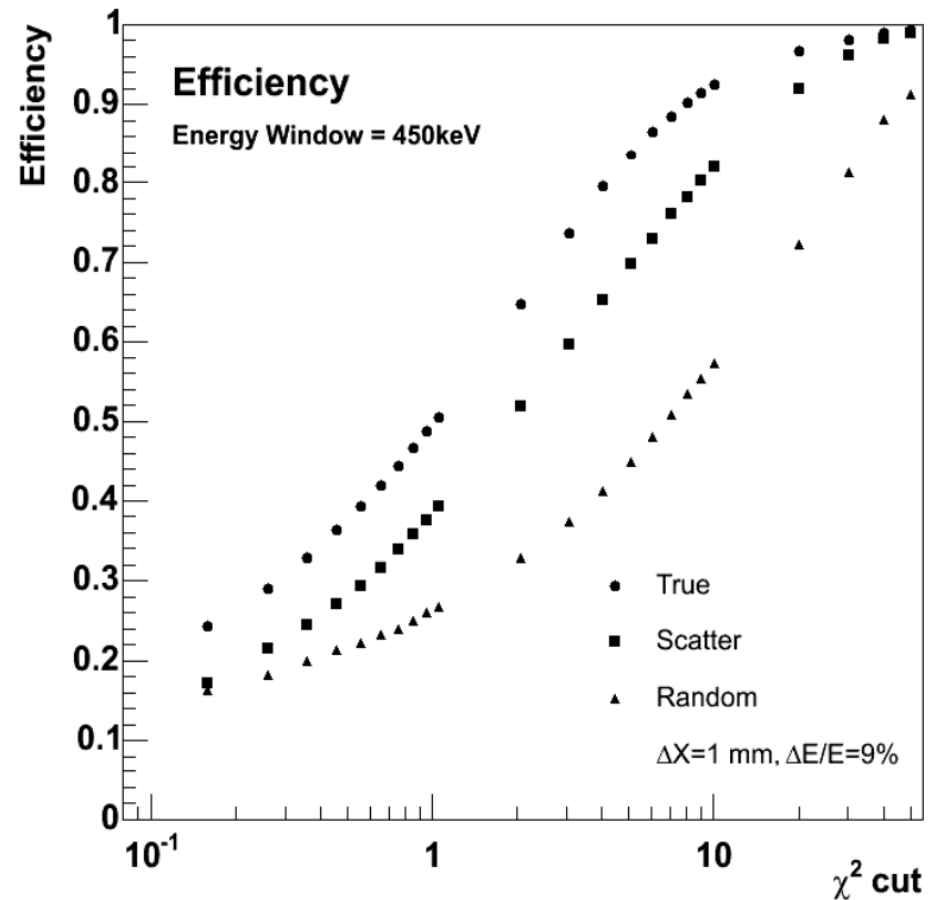
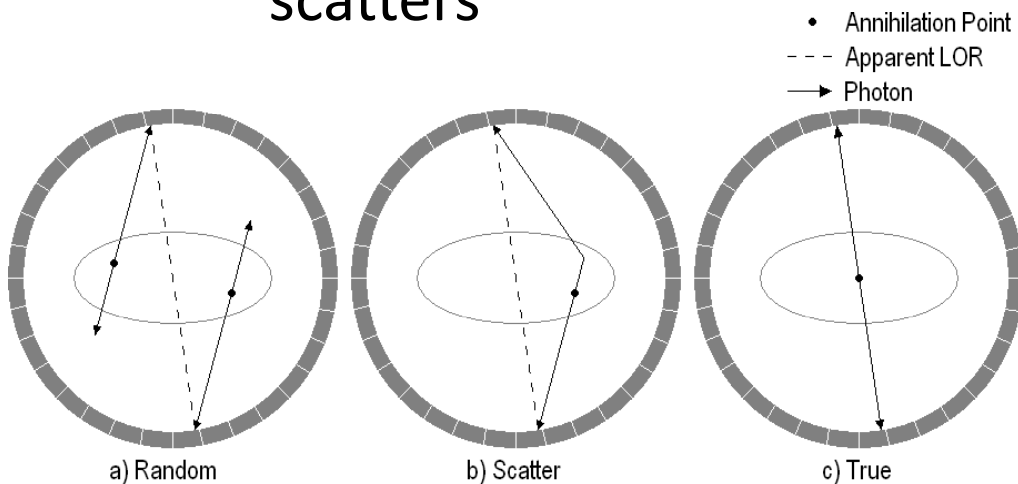
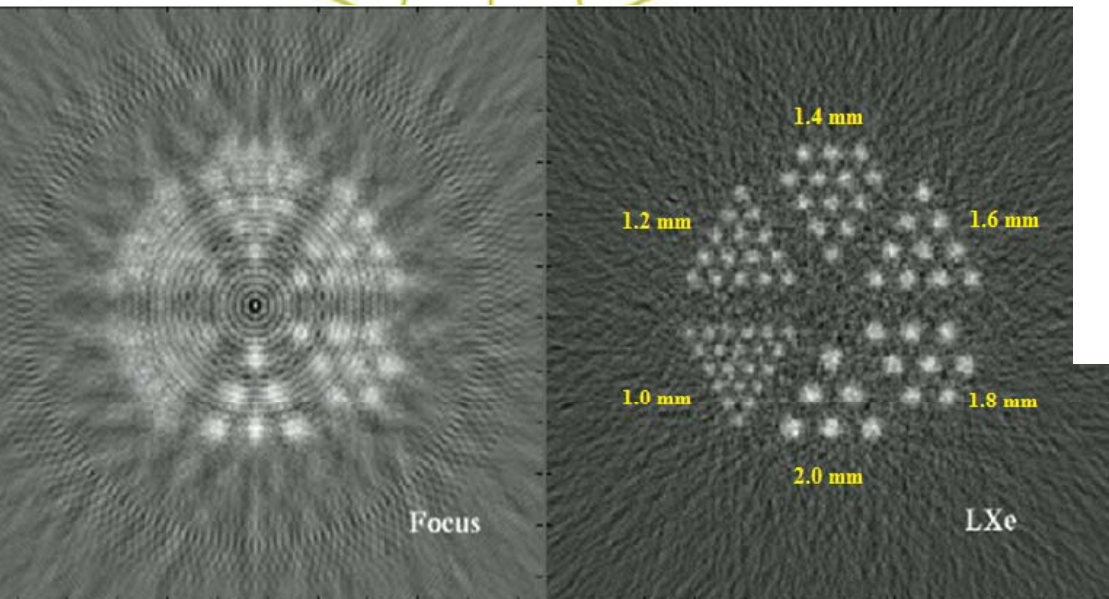
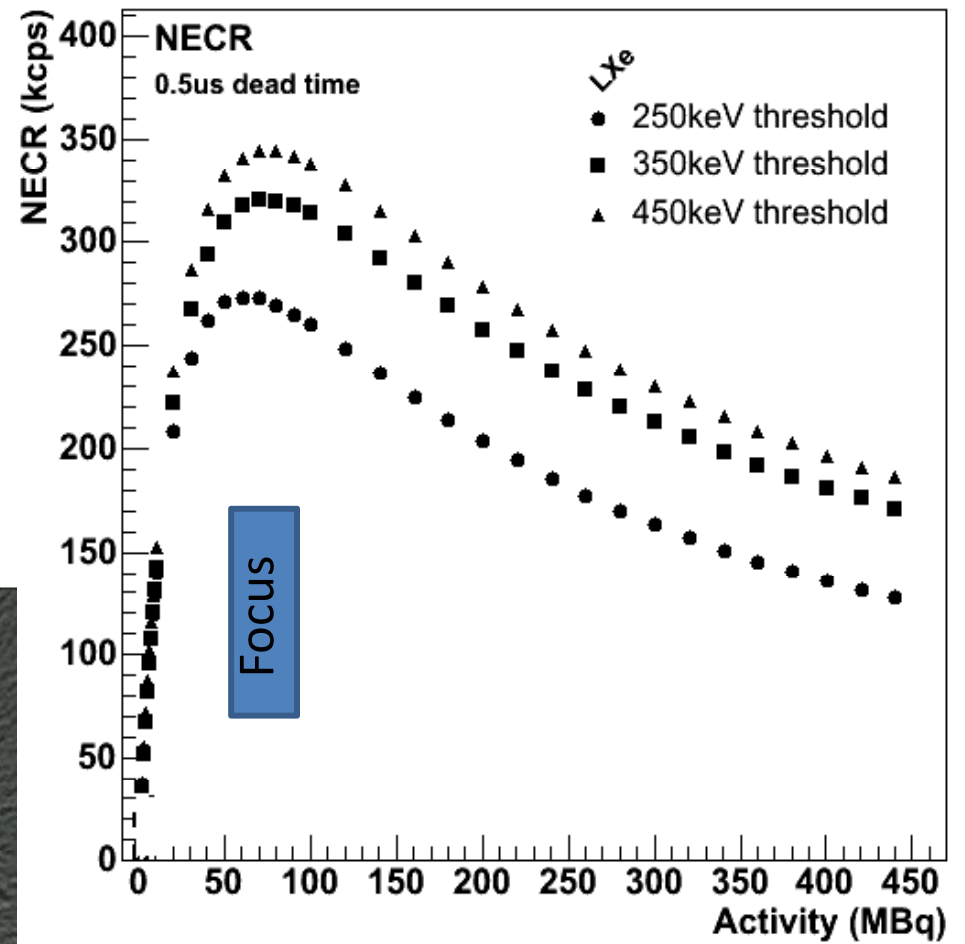
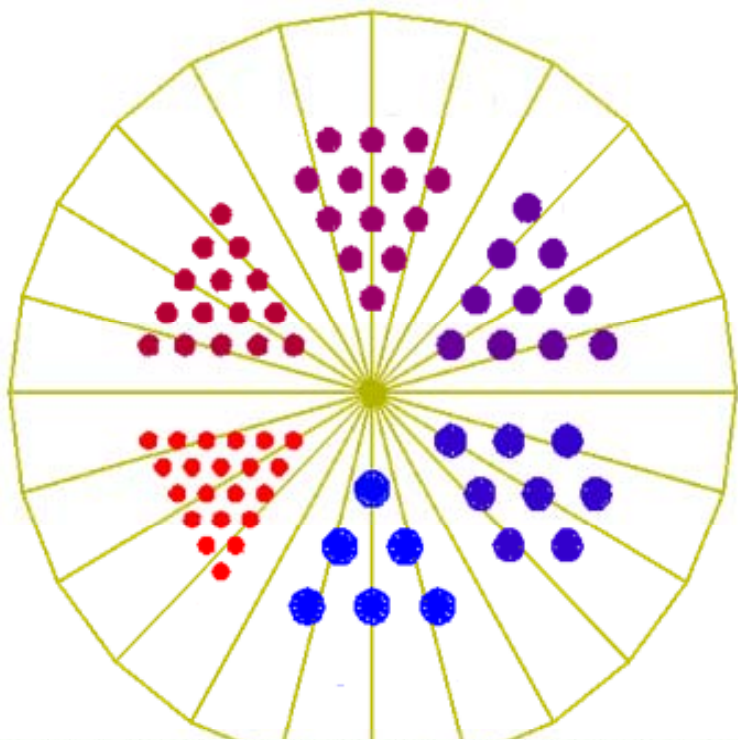

Image quality



Summary

- A liquid Xenon micro-PET detector is being developed
 - Concept is established
 - Prototyping is on-going
 - Energy resolution issues are understood
 - First sector operational very soon
 - Ring (2 sectors) operational in 2010
- Simulations show very significant improvement in image quality
 - Compton interactions must be handled with great care
 - Mis-identified Compton sequences dominate the background

BACKUP

Waveforms in small chamber

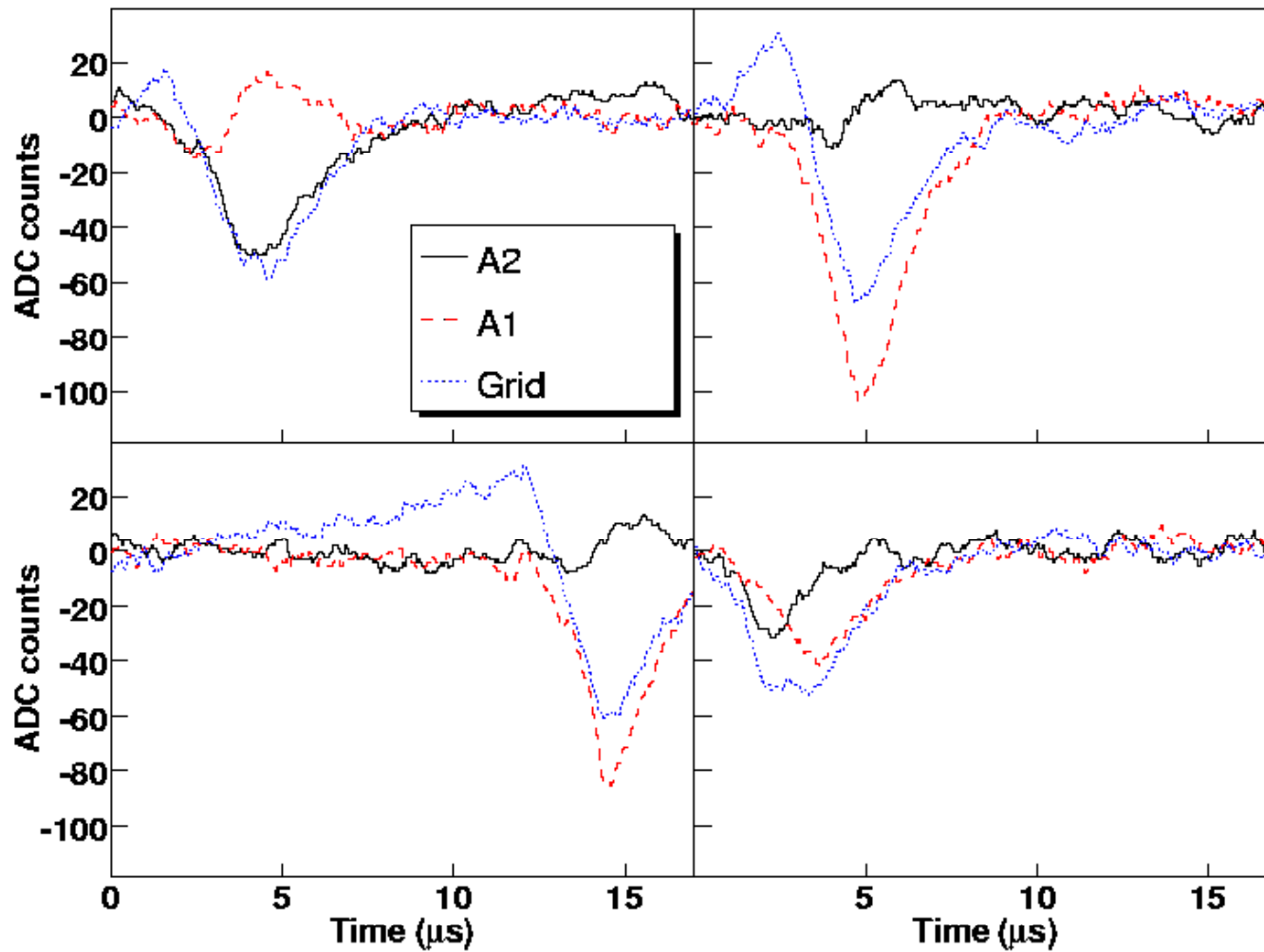

Charge and light collection in small chamber

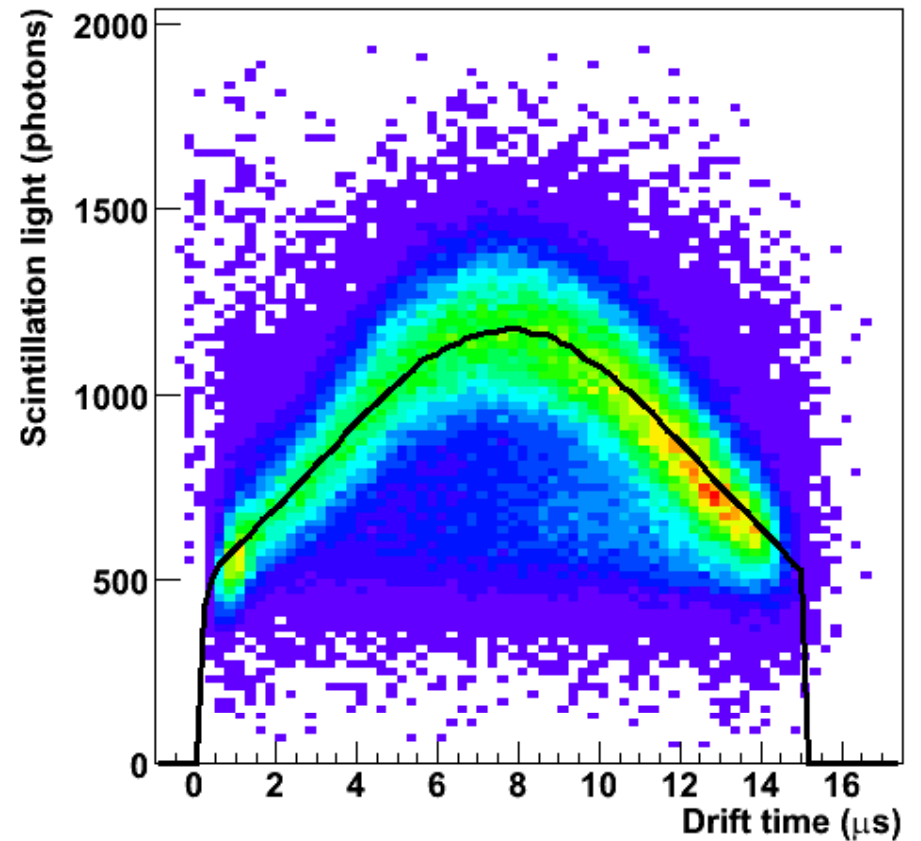
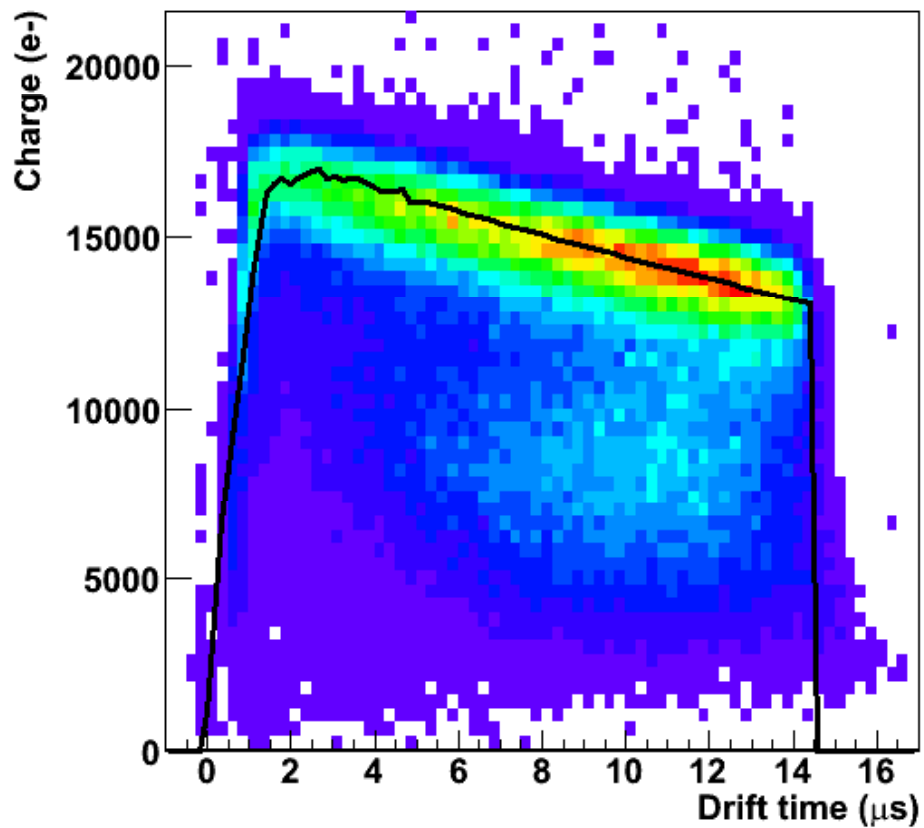

Chi2 vs topology

